



■ Vers. 239



■ Vers. 009



■ Vers.



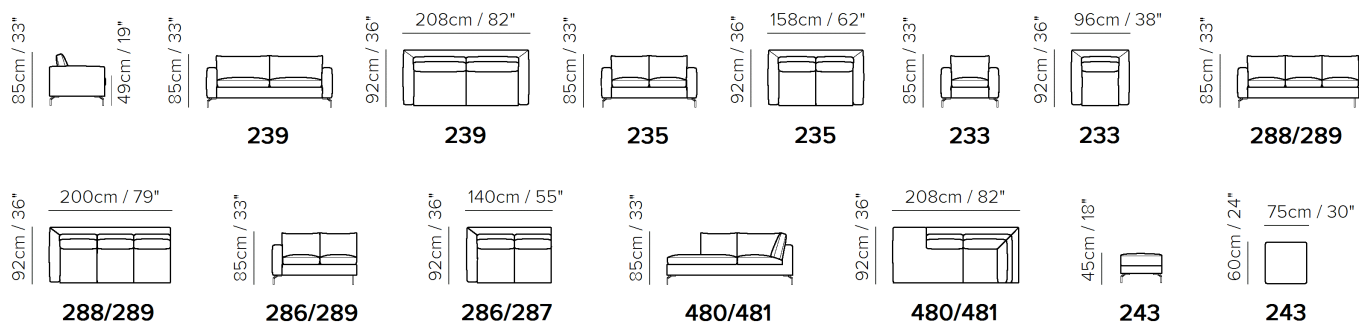

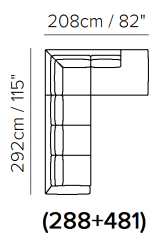

**SCHEMATICS**



**COMPOSITION EXAMPLES**



TECHNICAL INFORMATION

|  |                 |  |  |  |   |                                     |
|--|-----------------|--|--|--|---|-------------------------------------|
|  | <b>COVERING</b> | Leather<br><input checked="" type="checkbox"/>   | Soft Cover<br><input checked="" type="checkbox"/>  |  |   |                                     |
|  | <b>LEGS</b>     | Plastic<br><input type="checkbox"/>  | Metal<br><input checked="" type="checkbox"/>   | Wood<br><input checked="" type="checkbox"/>  | Upholstered<br><input type="checkbox"/> | Castors<br><input type="checkbox"/> |
|  | <b>FILLING</b>  | Arms<br><input type="checkbox"/> Fiber<br><input checked="" type="checkbox"/> Foam<br><input type="checkbox"/> Feather/Fiber Mix<br><input type="checkbox"/> Feather | Seat cushion<br><input type="checkbox"/> Fiber<br><input checked="" type="checkbox"/> Foam<br><input type="checkbox"/> Feather/Fiber Mix<br><input type="checkbox"/> Feather | Back cushion<br><input checked="" type="checkbox"/> Fiber<br><input type="checkbox"/> Foam<br><input type="checkbox"/> Feather/Fiber Mix<br><input type="checkbox"/> Feather |   |                                     |
|  | <b>COMFORT</b>  | Standard Comfort<br><input checked="" type="checkbox"/>  | Firm Comfort<br><input checked="" type="checkbox"/>  |  |   |                                     |
|  | <b>FUNCTION</b> | Bed<br><input type="checkbox"/>  | Electric motion<br><input type="checkbox"/>  | Motion<br><input type="checkbox"/>   | Recliner<br><input type="checkbox"/>    | Sliding<br><input type="checkbox"/> |
|  | <b>OPTIONS</b>  | Nails<br><input type="checkbox"/>  | Contrast Stitching<br><input checked="" type="checkbox"/>  | Removable<br><input type="checkbox"/>  |   |                                     |

NOTES

- Contrast stitching is available only with certain covers and option is managed directly in NARES.
- All arms, back and seat surfaces are covered in Top Grain.
- This model is available with split leather exterior covering (Side, Rear and Front Panels)
- Tight Seat Cushion (the seat cushions of the models are fixed to the frame)
- Back Cushion Zippered (the back cushion is attached to the frame through a zipper)
- No Leather Side (the sectional pieces have the side covered with lining and not leather)
- Internal wooden frame
- Without Feet Assembled (the feet will be in a bag inside the package)
- Plastic Wrap (the model will be wrapped in a plastic bag)
- Feet available in wood finishings 09 (Walnut) / 18 (Wengè)
- Second option versions have feet available in metal finishing 75 (Glazed Nickel) / 79 (Matte Black)
- Feet height 14,5 cm

NOTES

---